

2. solder
3. signal1
4. outline
5. componentmask
6. soldermask
7. plated-drill
8. topsilk
9. bottomsilk
10. topassembly
11. bottomassembly
12. fab

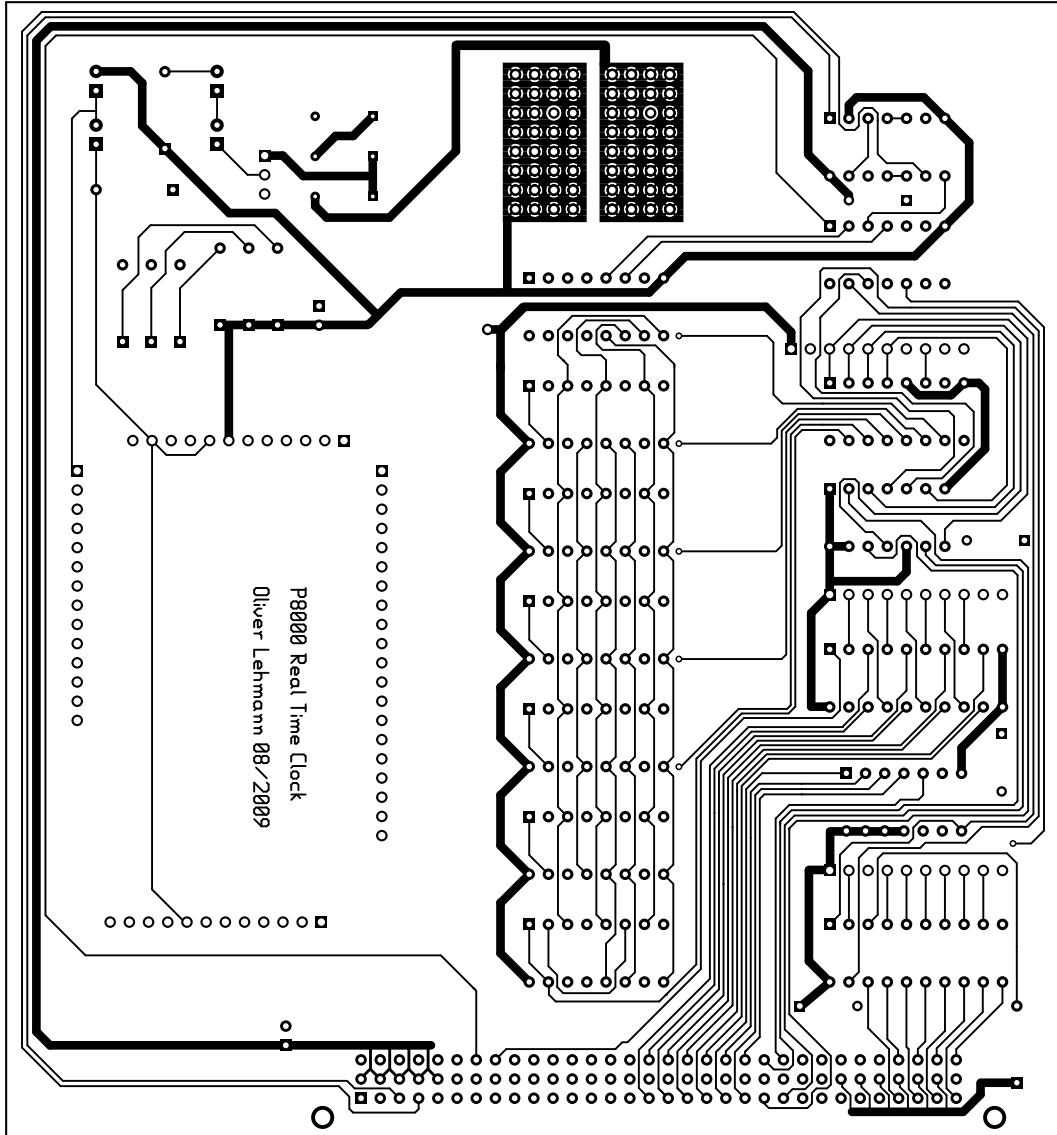

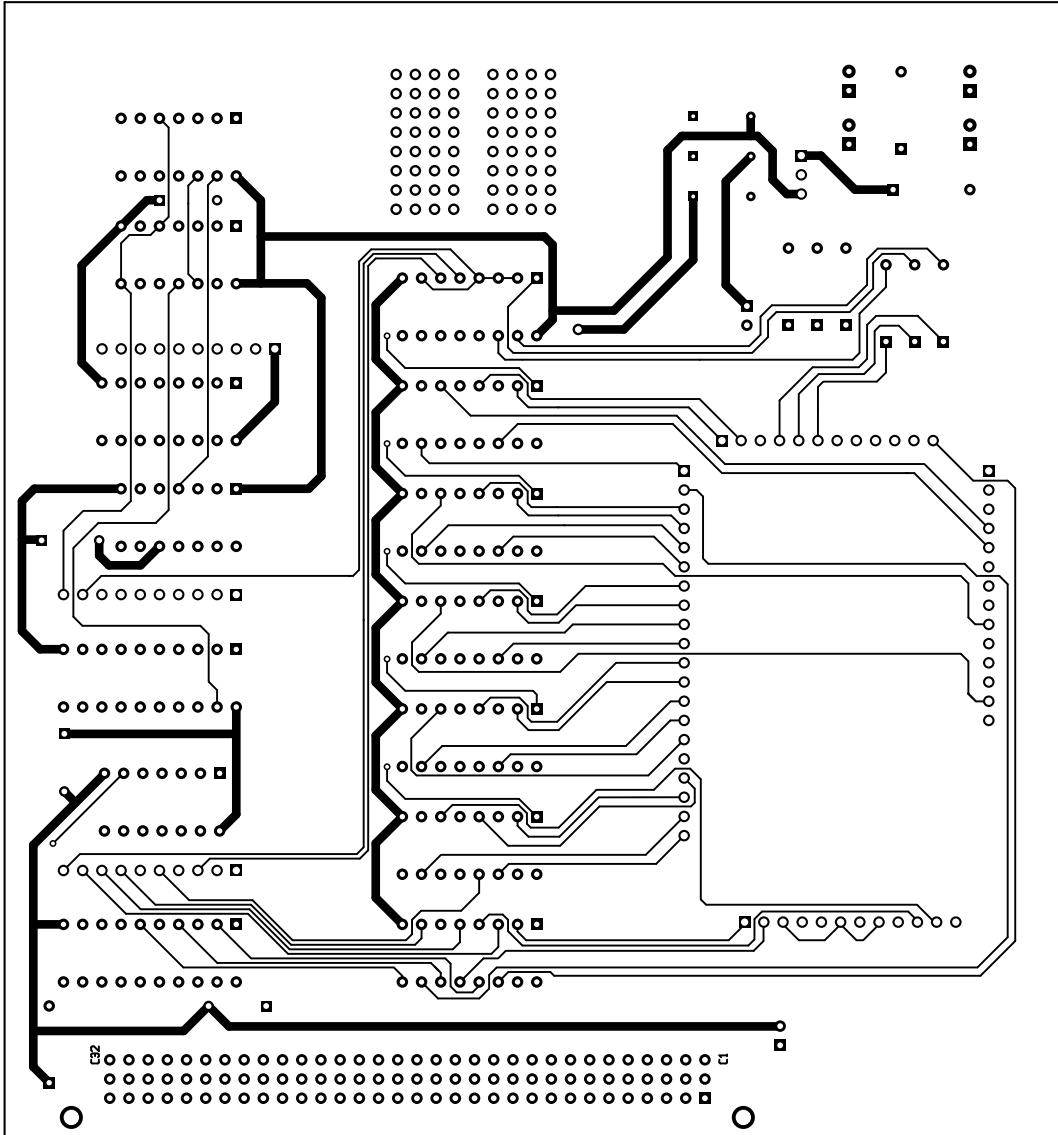

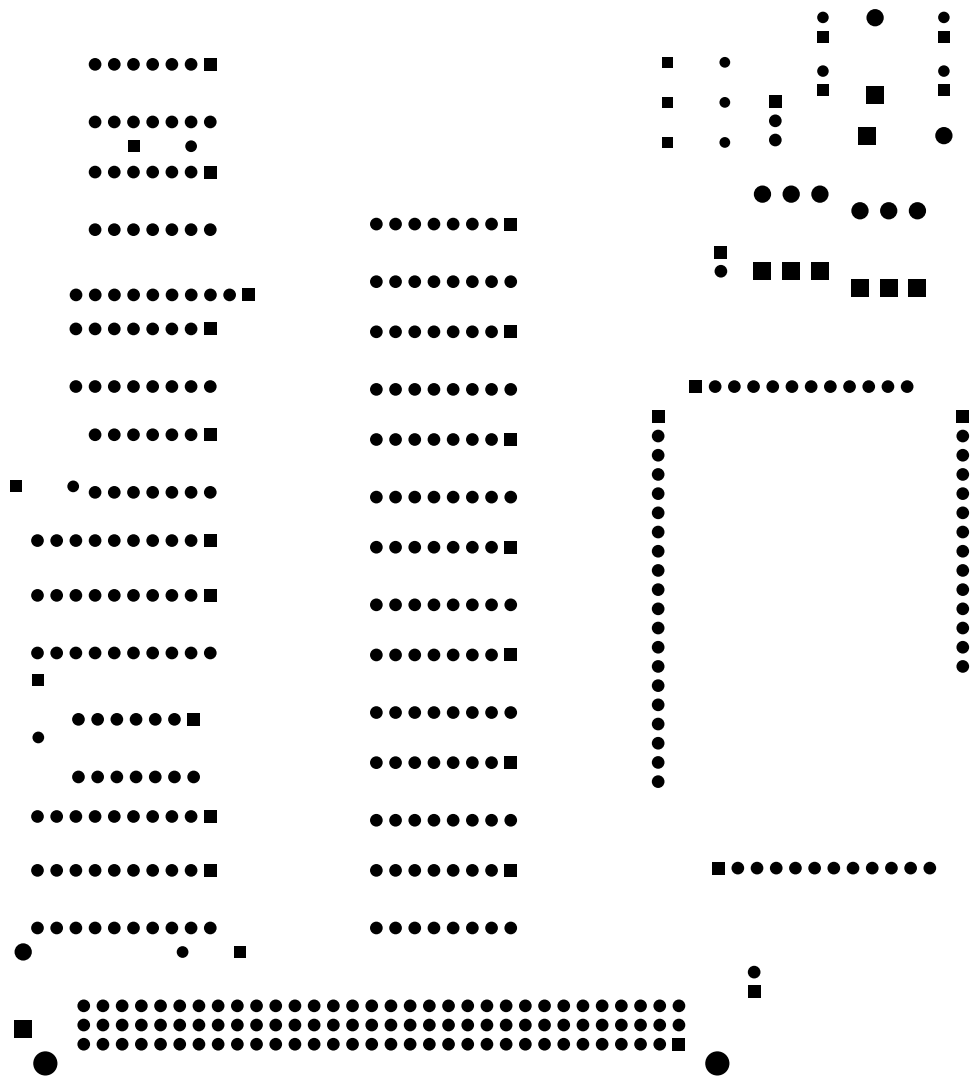



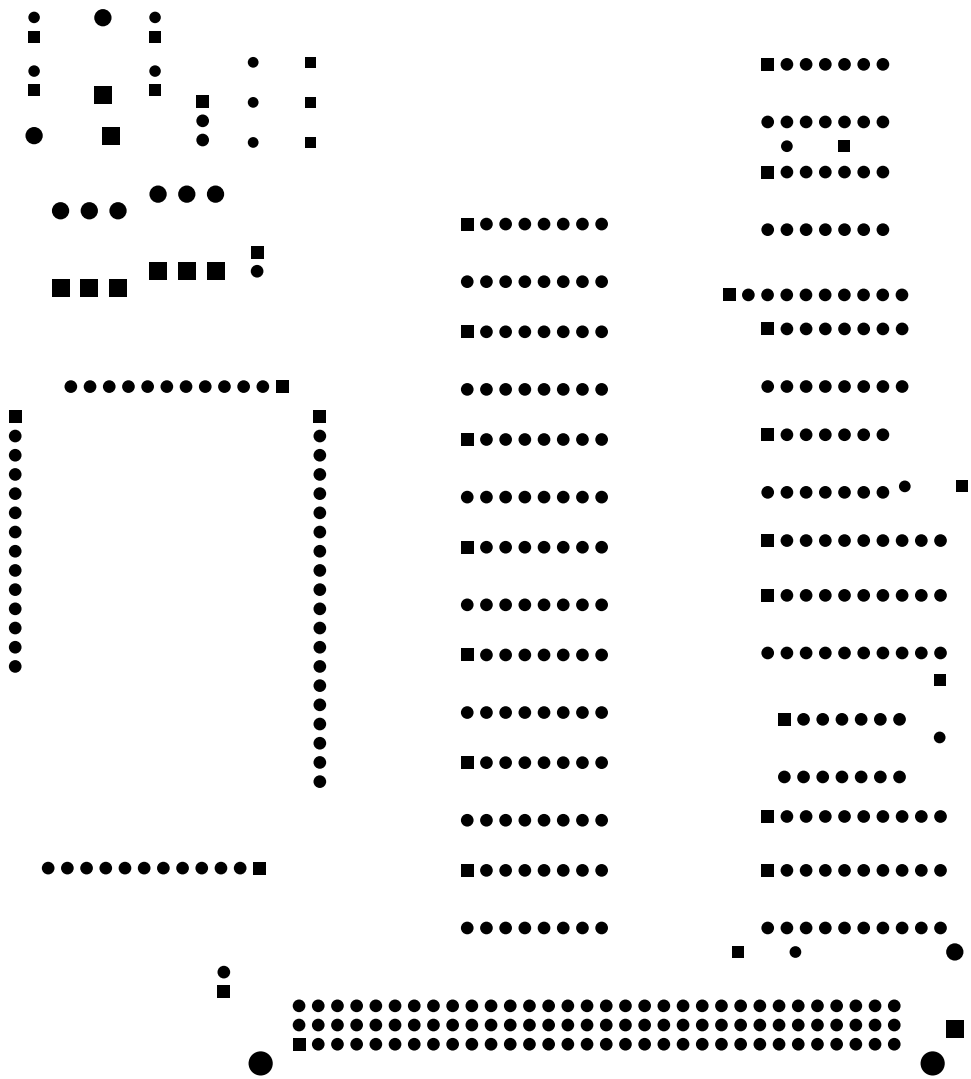

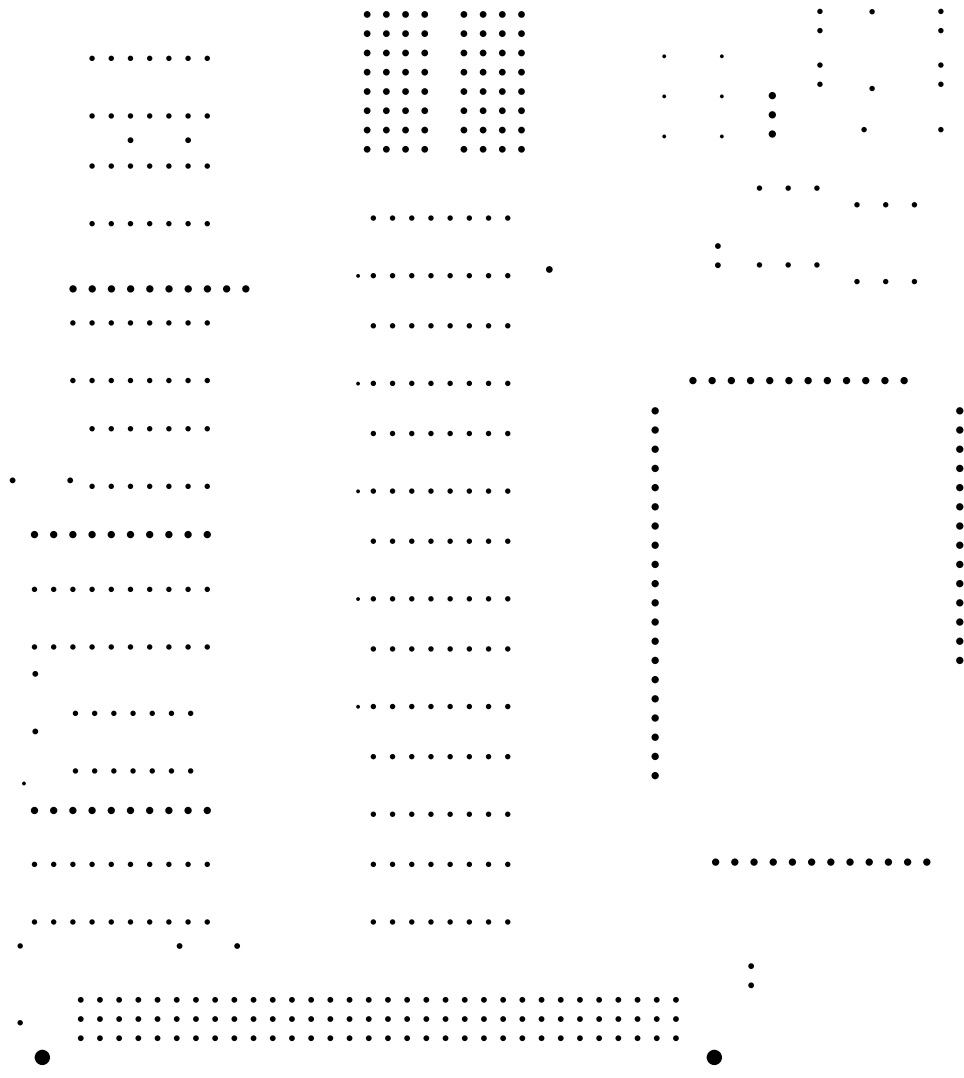

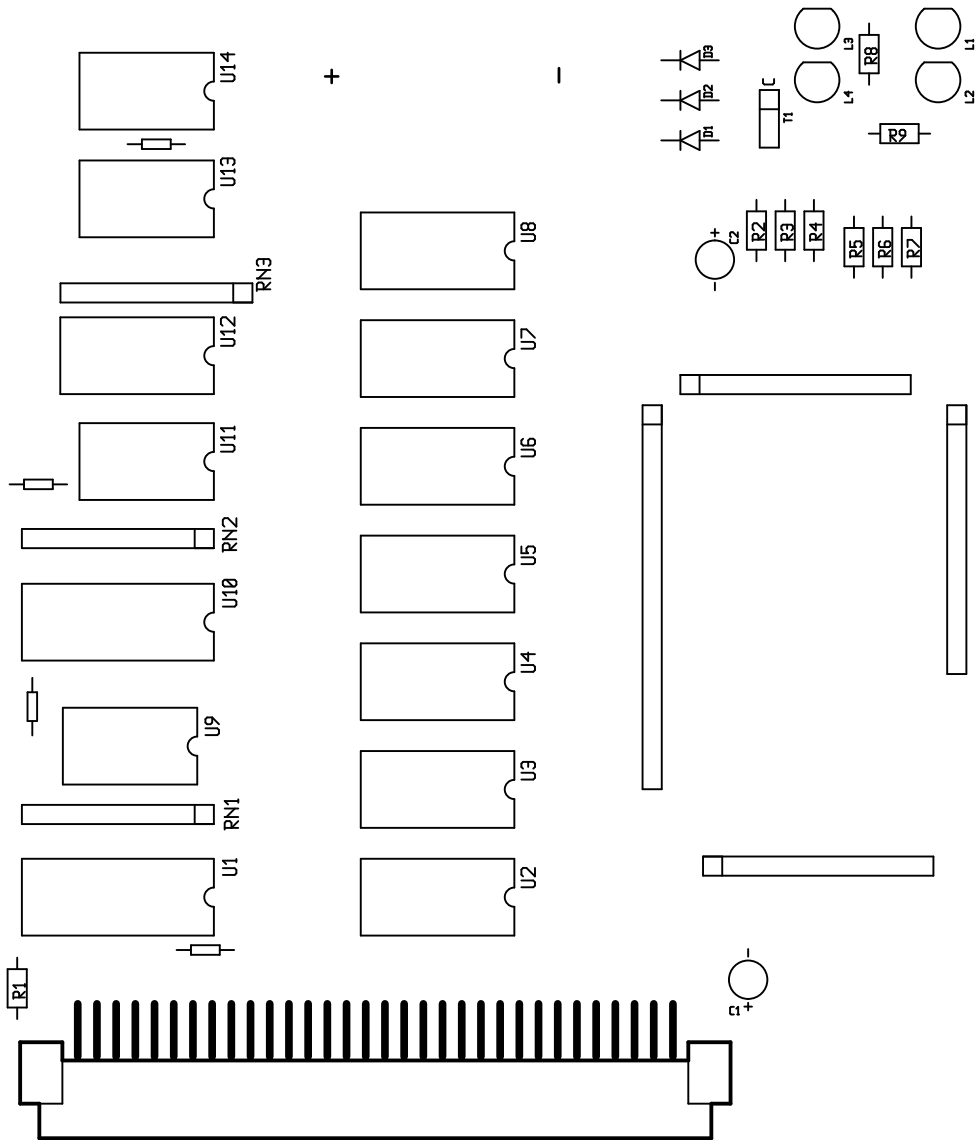





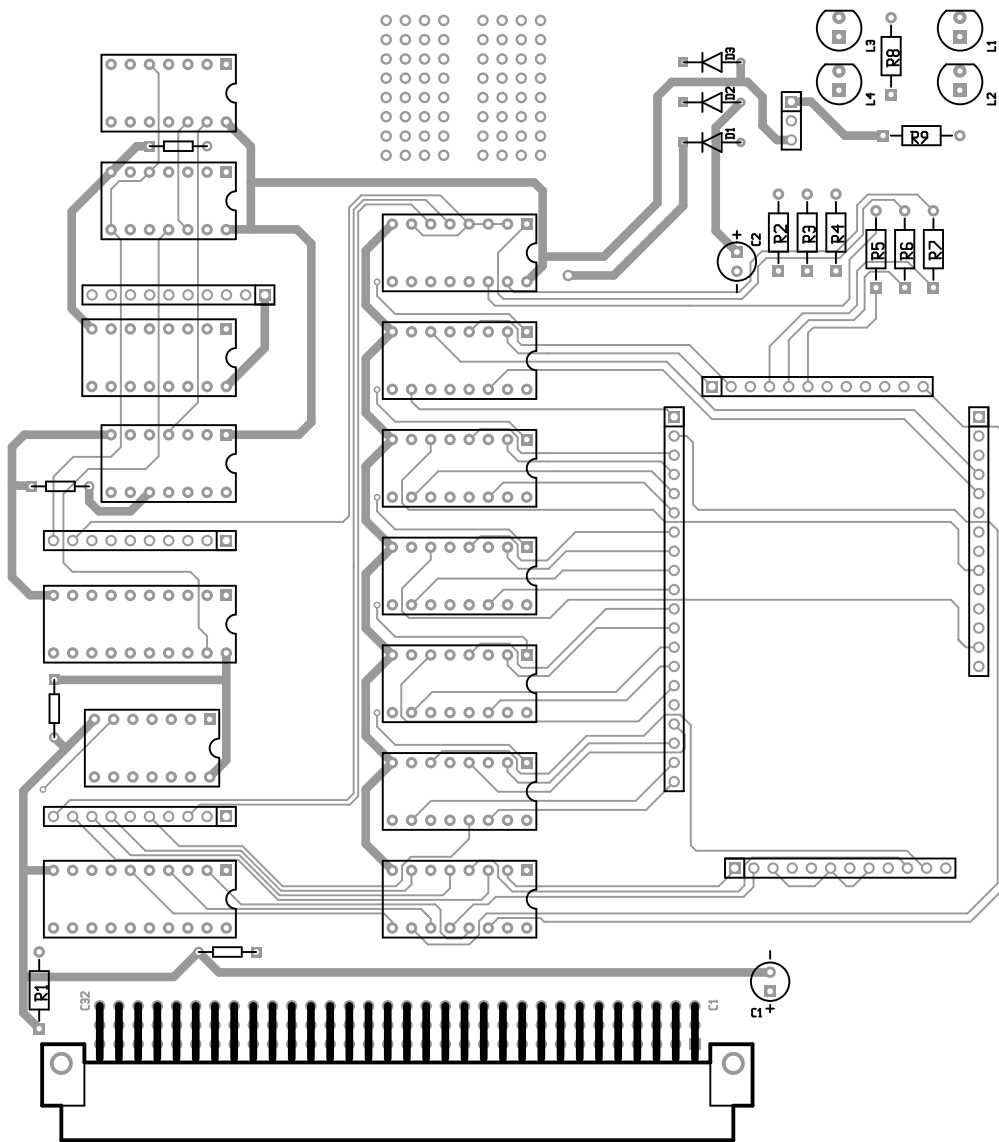

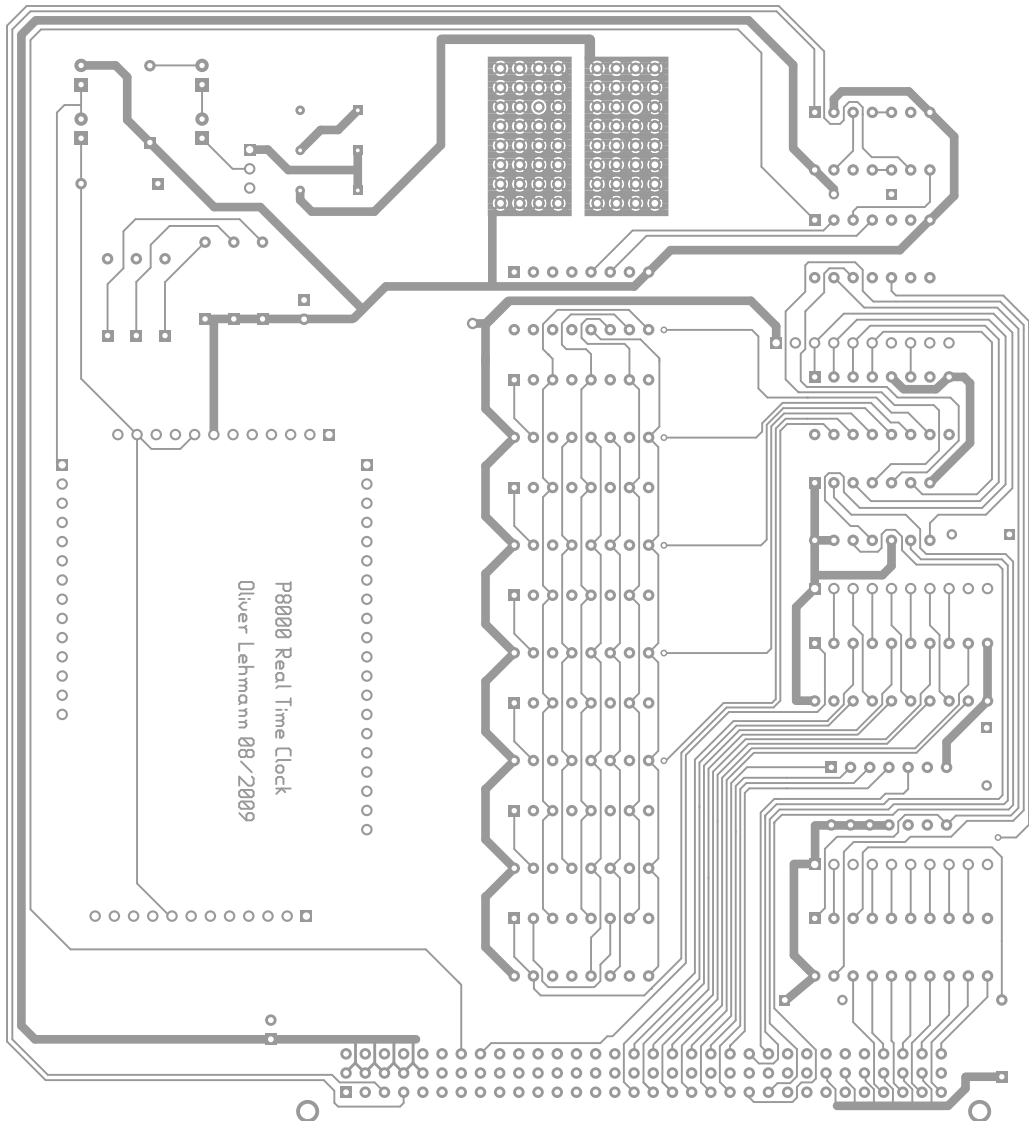

P8000 Real Time Clock  
Oliver Lehmann 08/2009

There are 6 different drill sizes used in this layout, 528 holes total

Symbol	Diam. (Inch)	Count	Plated?
Y	0.020	12	YES
+	0.028	250	YES
x	0.030	108	YES
o	0.035	65	YES
□	0.038	91	YES
▽	0.080	2	YES

Title: (unknown) - Fabrication Drawing  
 Author: Oliver Lehmann  
 Date: Fri Aug 21 17:55:59 2009 UTC

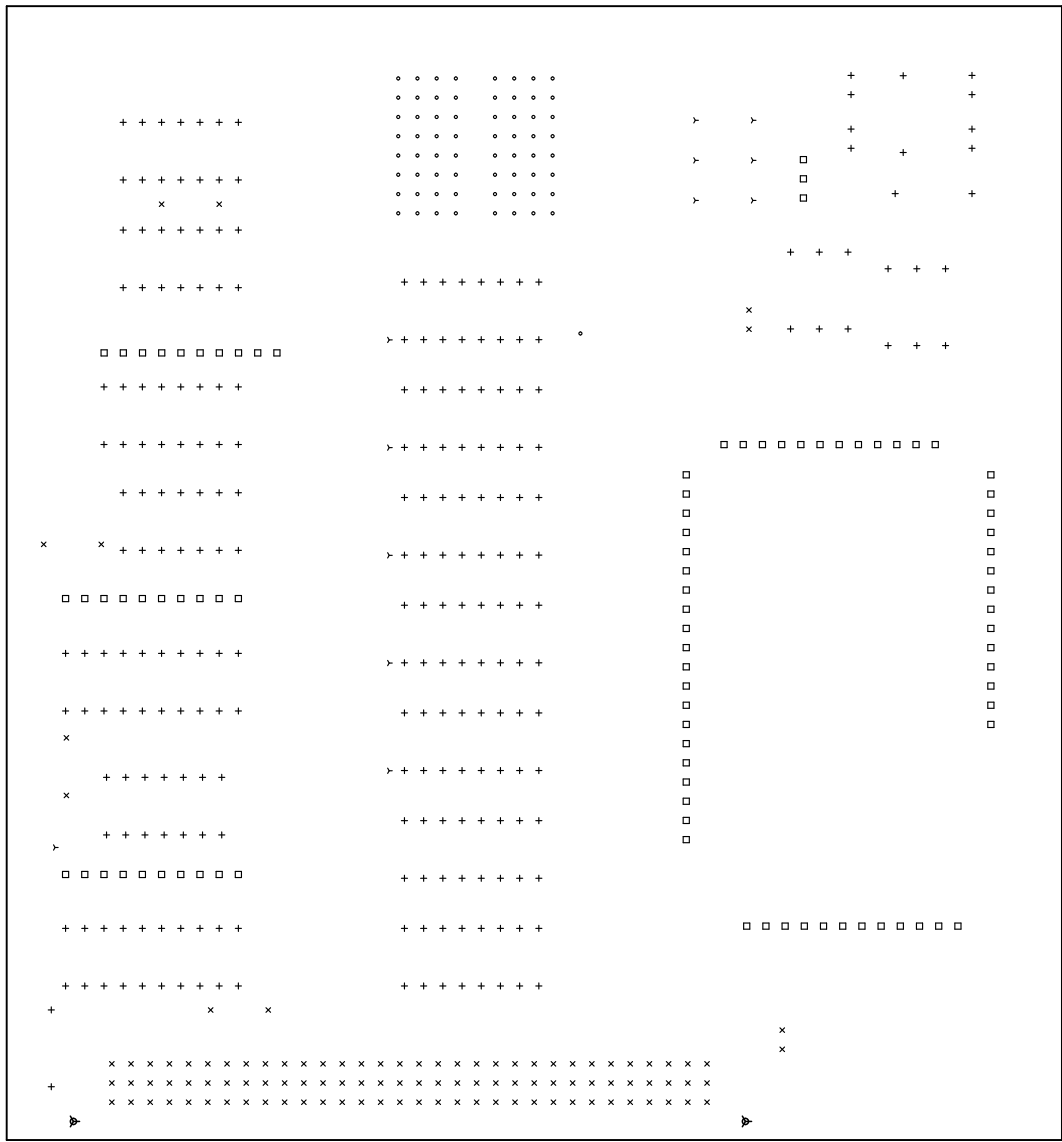

Board outline is the center-line of this path